

Common Rail Xingma Injector Nozzle DLLA148P1313 Technical File



XINGMA NOZZLE

Common Rail Xingma Injector Nozzle DLLA148P1313 Technical File

Content

1. DLLA148P1313 Xingma Injector Nozzle Introduction	3
1.1. DLLA148P1313 Xingma Injector Nozzle's Basic Information	3
1.2. DLLA148P1313 Xingma Injector Nozzle's Common Written Part Number	3
1.3. DLLA148P1313 Xingma Injector Nozzle's Application Information for Injectors	3
1.4. DLLA148P1313 Xingma Injector Nozzle's Specifications and Dimensions Parameters	3
1.5. DLLA148P1313 Xingma Injector Nozzle Quality Control	4
1.6. DLLA148P1313 Xingma Injector Nozzle's Customized Service	4
1.7. DLLA148P1313 Xingma Injector Nozzle's Packing List	4
1.8. DLLA148P1313 Xingma Injector Nozzle's Warranty Instructions	5
1.9. DLLA148P1313 Xingma Injector Nozzle's Manufacturer	5
2. DLLA148P1313 Xingma Injector Nozzle's Technical Support	6
2.1. DLLA148P1313 Xingma Injector Nozzle's Installation Precautions	6
2.2. DLLA148P1313 Xingma Injector Nozzle Inspection	6
2.3. DLLA148P1313 Xingma Injector Nozzle Test Measurement	6
2.4. DLLA148P1313 Xingma Injector Nozzle's Installation	7
2.5. DLLA148P1313 Xingma Injector Nozzle Testing After Maintenance	7
2.6. DLLA148P1313 Xingma Injector Nozzle List of Tools Used During Measurement and Installation	8
2.7. DLLA148P1313 Xingma Injector Nozzle Causes of Damage	9
2.8. DLLA148P1313 Xingma Injector Nozzle Technical Support Obtaining Methods	9
3. DLLA148P1313 Xingma Injector Nozzle's Purchase and Delivery	9
3.1. DLLA148P1313 Xingma Injector Nozzle's Purchase Payment Methods	9
3.2. DLLA148P1313 Xingma Injector Nozzle's Main Sales Market	9
3.3. DLLA148P1313 Xingma Injector Nozzle's Declaration Requirements	9
3.4. DLLA148P1313 Xingma Injector Nozzle's Shipping Ways	9
3.5. DLLA148P1313 Xingma Injector Nozzle's Lead Time	10
3.6. DLLA148P1313 Xingma Injector Nozzle's Logistics Time for Destination Out of China's Areas	10
3.7. DLLA148P1313 Xingma Injector Nozzle's Packing	10
4. DLLA148P1313 Xingma Injector Nozzle's Storage Standard	11
5. Company Information	12
5.1. Company Introduction	12
5.2. Sales-men's Contact Information	12
6. Copyright Statement	13

Common Rail Xingma Injector Nozzle **DLLA148P1313** Technical File

The nozzle is one of the main working parts of the fuel injector. It is responsible for injecting fuel into the combustion chamber and is a key component to achieve precise injection, oil mist formation, etc.

Injector nozzle is one of core components of fuel injector, also one of parts with the highest damage rate. When there is smoke, engine shake, difficulty of starting the engine, engine noise, oil leakage, you must check whether the nozzle is working normally.

1. **DLLA148P1313** Xingma Injector Nozzle Introduction

1.1. **DLLA148P1313** Xingma Injector Nozzle's Basic Information

Title	Common Rail DLLA148P1313 Injector Nozzle China Made New	Brand
SKU1		XINGMA

1.2. **DLLA148P1313** Xingma Injector Nozzle's Common Written Part Number

Injector Nozzle Order Number	Injector Nozzle Engraved Number
0433171820	DLLA148P1313

1.3. **DLLA148P1313** Xingma Injector Nozzle's Application Information for Injectors

(1) **DLLA148P1313** Xingma Injector Nozzle's Application for Injector Part Number

Injector Part Number	Injector Series	System Pressure	Re-manufactured Part Number	System Pressure
0 445 110 169	CRI2.1 (1600 BAR)	1600	0 986 435 176	1600
0 445 110 881	CRI2.1	1600	0 986 435 294	

(2) **DLLA148P1313** Xingma Injector Nozzle's Car Model Matching Information

Injector Part Number	Car Number	OE Number	OE Number	OE Number
0 445 110 169	NISSAN	16600 DC000		
	RVI (RENAULT VEHICULES IND.)	77 01 058 110	74 850 016 59BX	77 01 061 090

(3) **DLLA148P1313** Xingma Injector Nozzle Part Number Common Written

0433171820, DLLA148P1313, 0 433 171 820, DLLA 148 P 1313, 0433 171 820, DLLA148 P 1313, 0433171 820, DLLA148P 1313, 0 433 171820, DLLA148 P1313, 0 433171820, DLLA 148P1313, 0 433171 820, DLLA 148P 1313

1.4. **DLLA148P1313** Xingma Injector Nozzle's Specifications and Dimensions Parameters

Xingma Injector Nozzle Size: 6 cm*1.5cm *1.5 cm

Xingma Injector Nozzle Barrel Dimensions: 7 cm *2 cm *2 cm

Xingma Injector Nozzle Net Weight: 0.03kg

Xingma Injector Nozzle 10 PCS Per Box: 10 cm *8 cm *4cm

Xingma Injector Nozzle Weight 10 PCS Per Box : 0.3kg

Xingma Injector Nozzle Quality: China Made New Injector Nozzle

Xingma Injector Nozzle MOQ: 10 PCS

1.5. DLLA148P1313 Xingma Injector Nozzle Quality Control

(1) Xingma Injector Nozzle Testing

All parts of the Xingma injector nozzle are subjected to precision testing, high temperature testing, low temperature testing, withstand pressure testing, leakage testing, durability testing, and various working conditions testing.

(2) Xingma Injector Nozzle Inspection

The factory inspection of the Xingma injector nozzle is undergone full inspection, random inspection, and batch inspection three inspections. Different brands of test benches are used to test the same Xingma injector nozzle for a total of no less than three times for factory inspection, and the fuel injector installation testing environment are progressed in dust-free workshop.

(3) Xingma Injector Nozzle Installation

When install injector nozzle, Shumatt strictly complies with the standard of technical indicators to ensure that each nozzle meets the factory standards and usage standards.

1.6. DLLA148P1313 Xingma Injector Nozzle's Customized Service

(1) Xingma Injector Nozzle's Customized Service: Meet the customized needs of OEM manufacturers for shell lettering (logo, nozzle part number, date and series number), nozzle without lettering, nozzle tube, nozzle box customized etc.

		
Xingma Injector Nozzle Shell Lettering Content Customized	Xingma Injector Nozzle Without lettering Customized	Xingma Injector Nozzle Tube Customized
	/	/
Xingma Injector Nozzle Box Customized	/	/

(2) Xingma Injector Nozzle's Customized Service Quantity Requirements:

The purchased of Customized Xingma injector nozzle's shell lettering or without lettering are no less than 100 pieces.

The purchased of Customized Xingma injector nozzle's tubes are no less than 2000-3000 pieces.

The purchased of customized Xingma injector nozzle's boxes are no less than 1000 pieces.

Customized products involve the need of specify logo, the OEM manufacturer needs to provide trademark authorization and the sample of logo image file.

▲ Once the customized Xingma injector nozzle is sold, it can't be returned or exchanged if there is no quality problems.

1.7. DLLA148P1313 Xingma Injector Nozzle's Packing List

(1) Xingma Injector Nozzle's Spare Parts List

No.	1	2	3
-----	---	---	---

Image			
Name	Xingma Injector Nozzle Assy	Nozzle Tube	Xingma Injector Nozzle Box
Description	Xingma Injector Nozzle Part Number DLLA148P1313	Prevent Nozzle Rusting and Damaging from Collision	10 PCS/Box

- ▲ Minors are prohibited to use fuel Xingma injector nozzle assembly, nozzle packing box to avoid injury.
- ▲ Xingma injector nozzle box is recyclable and can be reused.
- ▲ Xingma injector nozzle barrels is non-degradable material, please dispose of it properly after use.

1.8. DLLA148P1313 Xingma Injector Nozzle’s Warranty Instructions

(1) . Xingma Injector Nozzle’s Warranty Conditions and Instructions

It is necessary to provide pictures, videos, or test reports detected by the Xingma injector nozzle inspection equipment when the Xingma injector nozzle is abnormal during use as evidence to feed back to the salesman. Abnormal conditions are properly explained such as: 1.Smoke, 2. Engine shake, 3. Difficulty starting the engine, 4. Engine noise, 5. oil leakage etc.

(2) . Xingma Injector Nozzle Warranty Coverage

Within 15 days after customer receives the **DLLA148P1313** Xingma injector nozzle if there is a performance failure and the product has no appearance damage, customer can choose to replace it or repair it; If the **DLLA148P1313** Xingma injector nozzle has performance problems during the warranty period (3 months), and it is confirmed that it is product’s problems after testing, you can contact our salesmen to replace the same model or a reworked product with the same performance for free; If the injector house has obvious scratches, it can only be repaired and it will be returned as it is if the product is confirmed to be fault-free.

(3) . Xingma Injector Nozzle Out of Warranty Coverage

- .The warranty period has expired.
- .Xingma injector nozzle failure caused by high temperature, high pressure, humidity, rain and snow, saline-alkali land, earthquake, and used in abnormal environment.
- .Xingma injector nozzle damage caused by man-made reasons (throwing, strong magnetic field magnetization, set fire).
- .Xingma injector nozzle failure or injector damage caused by non-injector design, technology, manufacturing, quality and other issues.
- .Xingma injector nozzle failure due to system pressure exceeding system approved pressure.
- .Xingma injector nozzle failure caused by system voltage exceeding approved voltage.
- .Xingma injector nozzle failure caused by impurities (water, lead, aluminum powder, iron powder, sulfide) in the system fuel exceeding the standard requirements.
- .Xingma injector nozzle failure caused by not installing according to the tightening torque specified in the vehicle engine maintenance manual (the tightening torque is too large or too small).
- .Xingma injector nozzle failure caused by not following the installation angle specified in the injector maintenance manual.
- .Xingma injector nozzle failure caused by not following the cleaning requirements specified in the injector maintenance manual.
- .Xingma injector nozzle failure caused by failure to replace consumable parts as specified in the injector maintenance manual.

1.9. DLLA148P1313 Xingma Injector Nozzle’s Manufacturer

Xingma injector nozzle’s manufacturer: Shenzhen Shumatt Technology Co., Ltd

2. DLLA148P1313 Xingma Injector Nozzle's Technical Support

2.1. DLLA148P1313 Xingma Injector Nozzle's Installation Precautions

- (1) Clean the Xingma injector nozzle in an ultrasonic cleaner for 3-5 minutes before installation, so as to make the stains, dust, rust-proof oil oxides, paraffin base, naphthenic base, intermediate base, salt, lead naphthenate, zinc naphthenate, sodium petroleum sulfonate, barium petroleum sulfonate, calcium petroleum sulfonate, tallow diamine trioleate, rosinamine on the surface of the valve assembly fall off.
- (2) Use compressed air to clean the cleaning fluid attached to the surface of the Xingma injector nozzle after cleaning, and clean it up to the standard of use, as below

2.2. DLLA148P1313 Xingma Injector Nozzle Inspection.

- (1) Check whether there is deformation, cracking, thread damage, quenching, leakage and rust in the guide sleeve, spring, gasket and tight cap of the nozzle. The tight cap of the nozzle must be replaced after being disassembled for more than 5 times, as shown in the following.



- (2) Replace the tight cap of the nozzle and the copper gasket of the Xingma injector nozzle.
 - (3) Check whether the gap between the nozzle needle and the nozzle shell is within the standard range and whether it reaches the standard for use.
- ▲ All parts should be examined for wear under a microscope at least 20 times larger.
 - ▲ Nozzle tight cap deformation, cracking, thread damage, quenching, leakage, will lead to black smoke vehicle cap, fuel injector damage.
 - ▲ Injector opening pressure greater than or less than the specified range may cause injector damage.
 - ▲ Failure to replace wearing parts in time during maintenance may lead to fuel injector damage.

2.3. DLLA148P1313 Xingma Injector Nozzle Test Measurement

- (1) Nozzle opening pressure test

Test whether the opening pressure range of the nozzle is within the range specified in the injector maintenance manual (to be verified), if not within the normal range, adjust the nozzle spring to adjust the gasket

- ▲ If the value is greater than normal, reduce the oil nozzle spring adjusting gasket; if the value is less than normal, increase the oil nozzle spring adjusting gasket.

- (2) Stroke Measurement of Nozzle Needle Valve

Use a measuring tool to measure whether the stroke of the nozzle needle valve is within the range (15-45um) specified in the injector maintenance manual. If not, adjust the stroke of the nozzle to adjust the gasket.



⚠ If the value is greater than normal, thicken the gasket for oil-nozzle needle valve lift adjustment; if the value is less than normal, reduce the gasket for oil-nozzle needle valve lift adjustment

2.4. DLLA148P1313 Xingma Injector Nozzle's Installation

(1) Tightening torque of Xingma injector nozzle

The torque lever and tightening moment specified in the injector maintenance manual must be installed when the Xingma injector nozzle is installed. (50Nm)

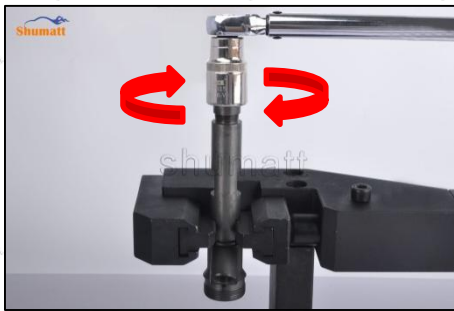

⚠ The tightening torque of the nozzle cap must be installed in accordance with the tightening torque specified in the injector maintenance manual

2.5. DLLA148P1313 Xingma Injector Nozzle Testing After Maintenance

(1) After installation, it needs to be tested on the test bench.

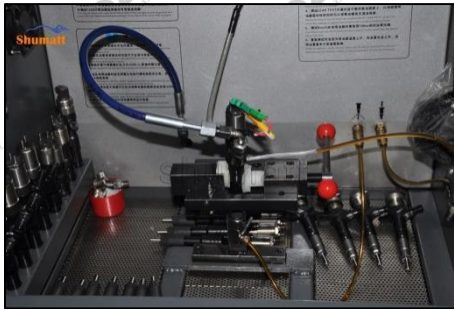

⚠ The correct injector type should be selected for testing

(2) . The test results need to be ensured that the following items are within the standard data range of the test stand.

LEAK TEST: Test whether sealing test is up to standard or not

In this step, no injector collector should be installed at the nozzle during the test so as to observe whether the nozzle is dripping oil, meanwhile observe that all joints are no oil leaking.

The static oil return of the test should not exceed 8mm²/H, otherwise, you need to check whether the high-pressure sealing ring, valve assembly, and stroke parameters of the injector are within the standard range.

VL: Test whether full load oil (main injection, high speed) is up to standard or not

This step needs to be combined with vehicle driving conditions, such as power, fuel consumption and smoke as well as the maintenance of the engine, if there is situation of insufficient power, fuel consumption is high, thick black smoke and irregularly maintenance of the engine, the engine needs to be maintained

according to the maintenance handbook at very first time.

Each of injector part needs to be adjusted and checked if there is any damage according to above situations to ensure the injector is normal. After make sure the injector works normal, you need to reduce the armature stroke if too much oil injection, and increase the armature stroke if too little oil injection.

The error of each injector should be controlled in 6mm³/HH when adjusting.

TL\EM: Test whether the torque point, emission point, exhaust limit, fuel supply reach standard or not Through this test, it is detected that when the oil injection is too little, the engine's acceleration is slow, vice versa, when the oil injection is too much, the engine's acceleration will produce black smoke and the engine excessive exhaust emissions.

Xingma injector nozzle spring force gasket, armature stroke, lift gasket and solenoid valve spring force gasket determine whether exhaust restriction and injector fuel supply reach standard

LL: Test if the idle fuel supply reached the standard

This test detects oil injection is too much will cause engine idle smoke, otherwise if the oil injection too little will cause engine idling easy to stall, or difficult to start.

The uneven of oil injection causes the unstable rotation speed of engine , making noise, and increase the engine swing in the acceleration process.

Each injector error should be controlled within 2mm³/HH when adjusting.

Idle speed fuel supply quantity mainly by adjusting the nozzle spring force gasket.

VE: Test whether the pre-injection meets the standard

This test detects when oil injection is too much will cause cylinder knocking while the engine is working and the exhaust emissions is not up to standard (smoke).

While when oil injection is too little will cause big noise while the engine is working, the engine is difficult to start, the engine weak acceleration, slow response of injector.

Each injector error should be controlled within 0.5mm³/HH when adjusting.

2.6. DLLA148P1313 Xingma Injector Nozzle List of Tools Used During Measurement and Installation

Image			
SKU	CRT084	CRT220	CRT079
Description	Torque wrench: 19-110nm 1/2 It is used to control tightening force and angle during installation	Fuel injector stroke measuring tool: is used to measure buffer stroke of fuel injector, armature stroke and remaining air gap	Micrometer: is used to measure gasket thickness
Image			

SKU	CRT281	
Description	Ultrasonic cleaning machine: is used for cleaning fuel injector and parts	Common rail injector test bench: check the injector working condition

2.7. DLLA148P1313 Xingma Injector Nozzle Causes of Damage

- (1) Fuel Xingma injector nozzle failure caused by impurities (water, lead, aluminum powder, iron powder, sulfide) in fuel exceeding standard requirements.
- (2) The nozzle is normally worn due to long time working under high temperature
- (3) Nozzle needle wear leads to oil hole blockage, insufficient fuel injection injector cannot work properly.
- ▲ Nozzle needle wear leads to oil hole blockage, insufficient fuel injection injector can't work properly.
- ▲ The wear of the nozzle leads to the increase of fuel quantity, resulting in black smoke of the vehicle, and the fuel injector can't work properly when it is serious.
- ▲ If the nozzle needle can't move smoothly stuck may cause serious damage to the Xingma injector nozzle
- ▲ The rusting of the nozzle spring leads to spring fracture and black smoke from the vehicle.
- ▲ The opening pressure of the nozzle decreases, and the oil quantity of the injector increases, leading to black smoke of the vehicle, and the injector can't work properly when it is serious.
- ▲ Oil-nozzle needle valve lift adjustment gasket wear oil-nozzle needle valve stroke becomes larger, the fuel injector oil quantity becomes larger, resulting in black smoke of vehicles, resulting in the fuel injector can't work properly when serious.
- ▲ The cracking of the nozzle cap is caused by high intensity work under high temperature.

2.8. DLLA148P1313 Xingma Injector Nozzle Technical Support Obtaining Methods

- (1) Xingma Injector Nozzle Technical File, visit <http://shumatt.com> to get the technical file
 - (2) **Injector Technical Videos**
- Facebook:** Visit <https://www.facebook.com/hison.li> constantly follow can get more information.
- YouTube:** https://www.youtube.com/channel/UCByvYBx7VjV_mAfxh_Hu-aw to get the technical videos, constantly follow can get more information.
- Shumatt:** Visit <http://shumatt.com> to get the technical videos.
- (3) Xingma Injector Nozzle Information Query Software
TruckBook Parts EPC APP, Android/Apple App Store download and install, visit <http://shumatt.com> to get the download and installation tutorial.
 - (4) Search The valve assembly test data through TruckBook Parts EPC APP.

3. DLLA148P1313 Xingma Injector Nozzle's Purchase and Delivery.

3.1. DLLA148P1313 Xingma Injector Nozzle's Purchase Payment Methods

Payment Methods: T/T, PayPal, Alipay, WeChat
 Please contact our salesmen for specific payment information.

3.2. DLLA148P1313 Xingma Injector Nozzle's Main Sales Market.

Xingma Injector Nozzle's main sales markets: Asia, Europe, North America, South America, Africa etc.

3.3. DLLA148P1313 Xingma Injector Nozzle's Declaration Requirements

Shumatt can assist customers to provide the following documents for import customs clearance: contract, invoice, packing list, bill of lading, insurance policy, certificate of origin, etc.

3.4. DLLA148P1313 Xingma Injector Nozzle's Shipping Ways

Destination in China areas: SF Express, Debon Express, the corresponding logistics company can be provided according to customer requirements in special cases.

Destinations out of China's areas: DHL, UPS, FedEx, TNT air, ocean or other shipping methods required by customers.

3.5. DLLA148P1313 Xingma Injector Nozzle’s Lead Time

Lead time: Send out within 3 – 7 working days after receiving payment (Except for special products and special cases) .

3.6. DLLA148P1313 Xingma Injector Nozzle’s Logistics Time for Destination Out of China’s Areas

DHL Logistics Time:

Country or Region of Departure	Hong Kong, China	Other Countries or Regions of Asia	Australia and New Zealand	Europe	America	Other Countries
China’s Mainland	7 Days	7 Days	8 Days	8 Days	8-12 Days	7-10 Days

UPS Logistics Time: Country or Region of Departure: China’s Mainland

Country of Destination	Estimated Arrival Time	Country of Destination	Estimated Arrival Time	Country of Destination	Estimated Arrival Time
Japan	3 Days	UK	5-7 Days	Egypt	5-7 Days
Turkey	5-7 Days	Singapore	3 Days	Switzerland	5-7 Days
Bahrain	5-7 Days	Latvia	7-10 Days	New Zealand	7-10 Days
Sri Lanka	5-7 Days	Thailand	3 Days	Austria	5-7 Days
Romania	5-7 Days	Vietnam	3-5 Days	Estonia	5-7 Days
Malaysia	3-5 Days	Israel	5-7 Days	Mexico	7-10 Days
France	5-7 Days	America	5-7 Days	United Arab Emirates	5-7 Days
Italy	5-7 Days	Netherlands	5-7 Days	Bengal	7-10 Days
Lebanon	5-7 Days	Philippine	3-5 Days	Greece	7-10 Days
South Korea	3 Days	Spain	5-7 Days	Myanmar	5-7 Days
Canada	5-7 Days	Germany	5-7 Days	Saudi Arabia	7-10 Days
Portugal	5-7 Days	Australia	5-7 Days	South Africa	7-10 Days
Denmark	5-7 Days	Belgium	5-7 Days	Ukraine	7-10 Days
India	7-10 Days	Qatar	7-10 Days	Poland	5-7 Days
Indonesia	3-5 Days	Morocco	7-10 Days	Pakistan	7-10 Days
Kuwait	7-10 Days				

The logistics time is for reference only, subjects are according to the actual arrival.

3.7. DLLA148P1313 Xingma Injector Nozzle’s Packing

Domestic express packaging: Usually wrapped in waterproof scotch tape, such as picture No.2.

International express packaging : Wrapped with waterproof yellow tape After wrapping the black protective film, such as picture No. 3.

Pallet Shipping: Use fumigation free and recycling trays that meet export requirements, and use white wrapping protective film to wrap and bind with cable ties for the outside, such as picture No. 4, Also, the products can be packaged according to customers’ requirements.

- ⚠ The packing tray is made of plastic and can be recycled.
- ⚠ Transparent tape, yellow tape, black wrapping protective film, white wrapping protective film are non-degradable materials, please dispose of them properly.
- ⚠ Minors are prohibited from using transparent tape, yellow tape, black wrapping protective film,

and white wrapping protective film to avoid personal injury.



Pic No.2

Domestic express packaging:
Wrapped by Transparent tape



Pic No.3

International express packaging:
Wrapped with yellow tape after wrapping
black protective film



Pic No.4

Pallet Shipping: Use pallet that meet export requirements, and use white wrapping protective film to wrap and bind with cable ties

4. DLLA148P1313 Xingma Injector Nozzle's Storage Standard

(1) Choose a suitable storage place

The warehouse and cargo yard where the fuel injector is stored should be kept clean and dry, and away from the factory buildings that generate harmful gases and dust; do not mix with acid, alkali, salt and other substances; the storage place should have a good drainage system; the cargo yard should be flattened with gravel or furnace ash etc. to enhance the water permeability of the surface layer to keep the reservoir area dry.

(2) Strict requirements of warehousing

Strict inspections should be carried out when the fuel injectors are put into storage, the surface cleaning work should be done well to remove water traces, oil stains, ash and other dirt, remove the rust and do anti-rust treatment in time. Packaged injectors must be protected from damage.

(3) Keep the warehouse dry and preventing moisture



The relative humidity is usually below 70% for the fuel injectors placed in the room, and the corrosion of the fuel injectors is significantly reduced.

Injectors must be stored in the warehouse, and they are forbidden to store in the same warehouse with commodities with high water content.

(4) Stack Properly



After the injector is exposed to rain, the corrosion rate will increase significantly. The purpose of sealing is to isolate the injector from rainwater and humid air, so the warehouse window should be checked in time to avoid rainwater entering the warehouse

If the fuel injector package is damaged, it should be repaired or replaced; when the package is damp, the packaging material should be dried; if the original anti-corrosion and oil applied at the factory is found to be damaged or dried up, it should be cleaned and re-applied oil in time.

-  It is forbidden to leave the injector exposed in the air for a long time.
-  It is forbidden to store acid, alkali, salt and other substances together with the injector.
-  The unpacked fuel injector must be rust-proof during secondary storage.

5. Company Information



-  Office Locations
-  Global Exhibitions

5.1. Company Introduction

Chinese Name: 深圳市舒马特科技有限公司

English Name: Shenzhen Shumatt Technology Co., Ltd

Mob Phone/WeChat: +86-13410541523

HK Telephone: +852-67653519

Telephone: +86-755-23215133

Email: ruby@shumatt.com

Website: www.shumatt.net

Shenzhen Office: 11-12, Floor 14, Building 13, Qinchengda Building, Exit A, Honglang North Subway Station, Bao'an District, Shenzhen, China's Mainland

Shenzhen Office: Room 428-430, Building B, Huafeng Zhigu Technology Industrial Park, Exit B, Fuyong Metro Station, Bao'an District, Shenzhen, China's Mainland

Hong Kong Office: Jianfa Street Industrial Zone, Tuen Mun, New Territories, Hong Kong, China

After-sales Service Address: Please contact our salesmen to obtain and provide the corresponding product maintenance reasons (Reference: [1.8. DLLA148P1313 Injector Warranty Instructions](#))

5.2. Sales-men's Contact Information

No.	Name	WeChat/ WhatsApp	Email
1	Ruby	+86-13410541523	ruby@shumatt.com

6. Copyright Statement

All trademarks, logos and service marks appearing on xingmanozzle.com are owned by xingmanozzle.com or the third party with legal rights. Without the written permission of xingmanozzle.com or the third party, it is prohibited to use, permanently download, copy, distribute, or mirror in any way.

The copyright of “Common Rail Xingma Injector Nozzle [DLA148P1313 Technical File](#)”, other data, images, videos, sound, or any contents quoted from Shenzhen Shumatt Technology Co., Ltd belongs to Shenzhen Shumatt Technology Co., Ltd, xingmanozzle.com has been authorized to use legally. Any users or organizations that download, reproduce, distribute and use these contents without written permission by Shenzhen Shumatt Technology Co., Ltd will bear legal responsibility.